

EQUIPMENT FOR SAFE HANDLING OF RADIOACTIVE ISOTOPES

OTTO GLASSER, PH.D. and BERNARD TAUTKINS

Department of Biophysics

THE use of radioactive isotopes in medical institutions is growing continuously. Shipments of radioactive isotopes for medical therapy from the Oak Ridge National Laboratory have increased from approximately 500 in 1947 to 5000 in 1952. Proper protection against undesirable radiation of all those handling radioactive materials is of utmost importance and numerous articles and books on "health physics" are available.¹

Many pieces of safety equipment for handling radioactive isotopes are commercially available. They comprise lead and iron bricks (regular or interlocking), lead and iron storage containers, mobile lead safety shields and carriers, lead test tube racks, remote handling tongs and remote pipetting devices. Yet many isotope laboratories are confronted with individual protection problems which cannot always be solved with equipment on the market. Most commercial equipment is also expensive, and not all laboratories can afford this expense in addition to the fundamentally necessary instruments such as Geiger counters and monitors.

For these reasons we have constructed during the last few years several pieces of safety equipment which have proved useful. Although some of these pieces seem to be novel, no originality is claimed for any of the units described. These units are used in the Clinical Isotope Section at the Cleveland Clinic where the two isotopes, I^{131} and P^{32} , are used almost exclusively.

Isotope Storage Unit. A convenient storage arrangement can be set up with 2 by 4 by 8 inch lead bricks, which form the body of the unit, and 2 by 4 by 4 inch bricks for the top cover, as illustrated in the photograph and schematic drawing in figure 1. We were fortunate to inherit tons of lead from an old x-ray therapy department which was dismantled and the bricks were cast in our mechanical department. As can be seen in the photograph, they are left in the rough, except for those surfaces upon which the top cover bricks slide which are machined. Holes (diameter $1\frac{5}{8}$ inches, depth $3\frac{1}{8}$ inches) are drilled off-center in the middle layer of bricks to hold the bottles containing radioactive isotopes. Their position is so arranged that the radiation hits the places where the bricks touch obliquely, thus avoiding the necessity of using interlocking bricks. In the setup in figure 1 there are six numbered holes (only one is evident); five can be occupied leaving one space open to move the cover bricks. (Two of the cover bricks have been removed in the photograph to give a clearer view of the construction.) This storage unit is simple, cheap and flexible. It can be easily extended if more storage space is needed. It also can be easily dismantled and de-contamination is no problem.

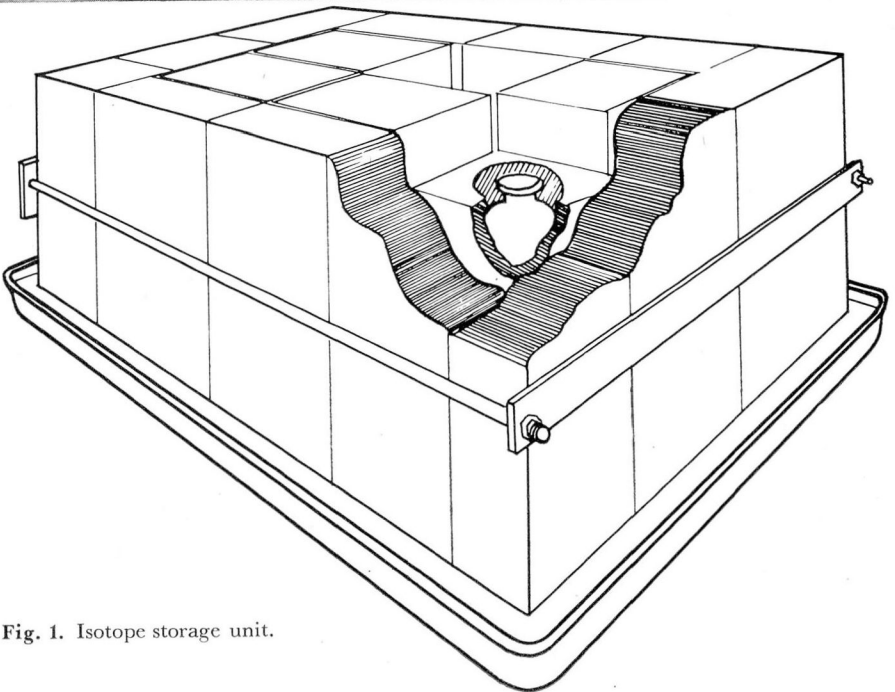
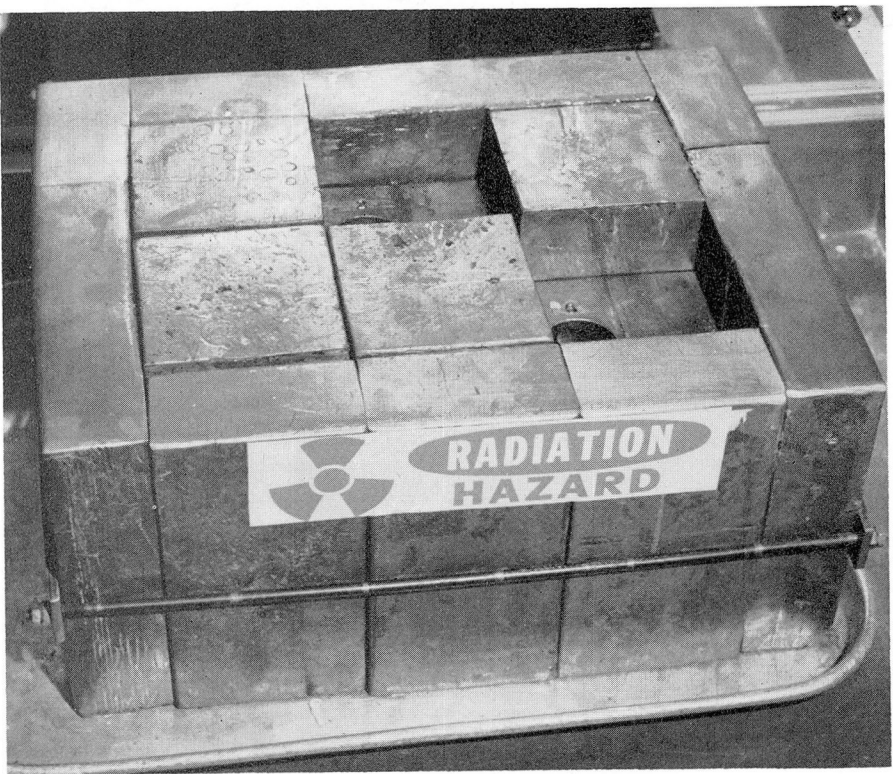

Fig. 1. Isotope storage unit.

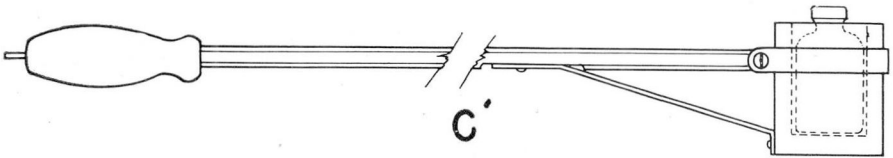
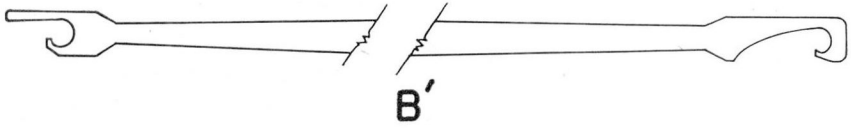
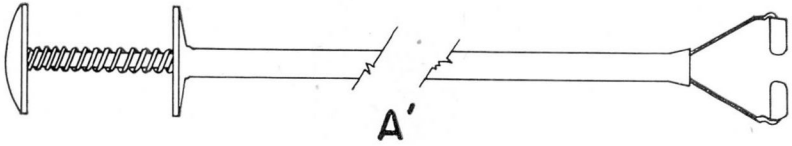
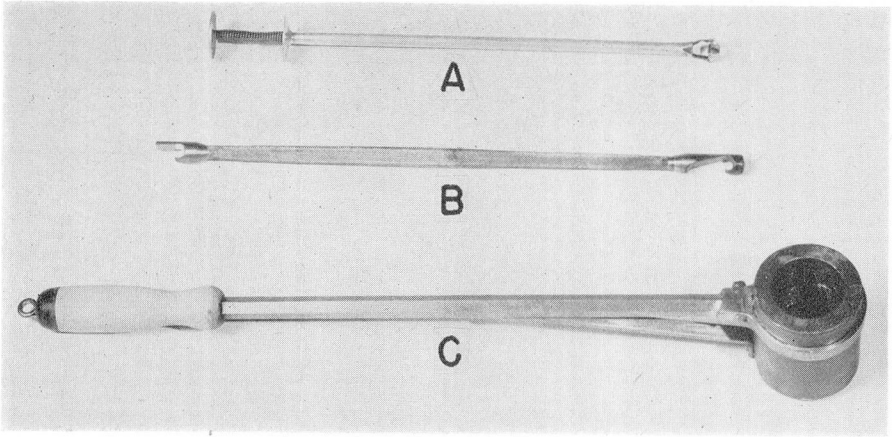

Fig. 2. Bottle cap remover and isotope carrier.

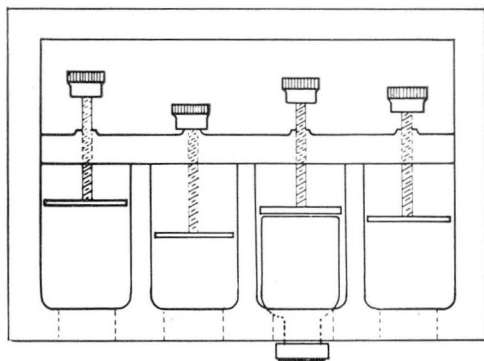
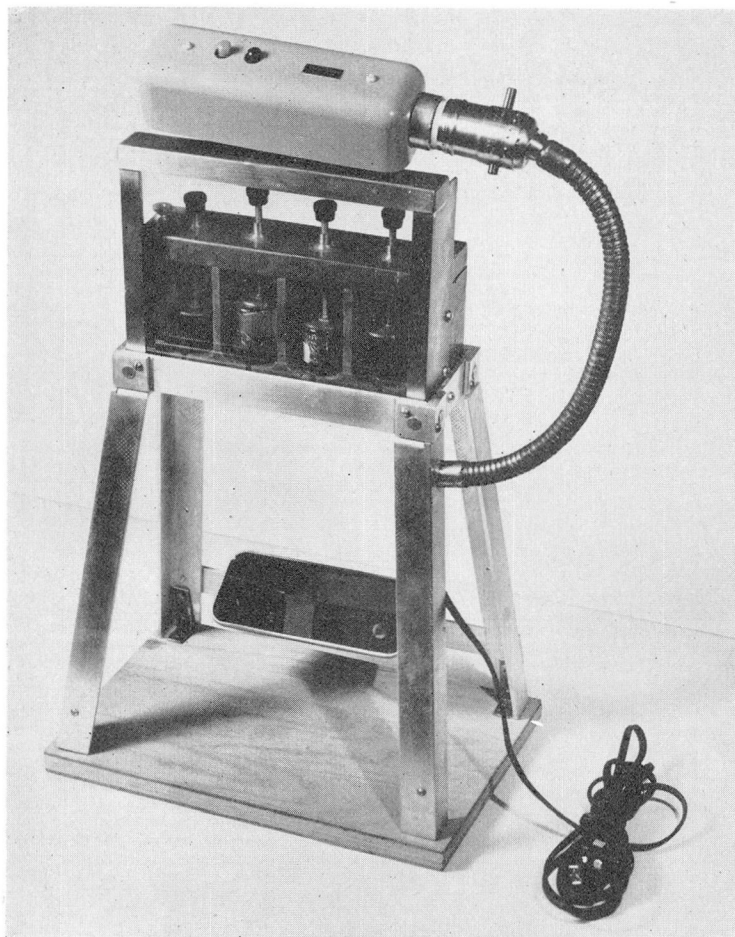

Fig. 3. Intravenous tracer bottle holder.

Bottle Cap Remover. Bottles with radioactive isotopes from Oak Ridge National Laboratory have screw caps, and returnable shipping containers are equipped with a bottle cap remover which permits easy removal of the cap. Sterile isotope solutions from pharmaceutical firms however come equipped with rubber stoppers and aluminum seals. These are difficult to open safely with ordinary laboratory tools. In order to overcome this difficulty we constructed the tools illustrated in the photograph and schematic drawings of figure 2. Figure 2 A and A¹ is a pick-up (length 12 $\frac{7}{8}$ inches) for the isotope bottle. Upon pressure on the button at one end, tongs with semicircular ends spread at the other end. They grasp the neck of the bottle and permit safe transfer to the lead carrier (length 18 $\frac{1}{2}$ inches, lead thickness $\frac{7}{16}$ inch) illustrated in figure 2 C¹. The neck of the bottle protrudes above the upper edge of the container and permits easy removal of the rubber stopper and aluminum seal by means of either end of the bottle cap remover (fig. 2 B, B¹). For bottles with smaller diameters than illustrated, sleeves can be inserted into the lead carrier in order to hold the bottle tightly for cap removal. Both tongs and lead carrier lend themselves to many other uses in the isotope laboratory.

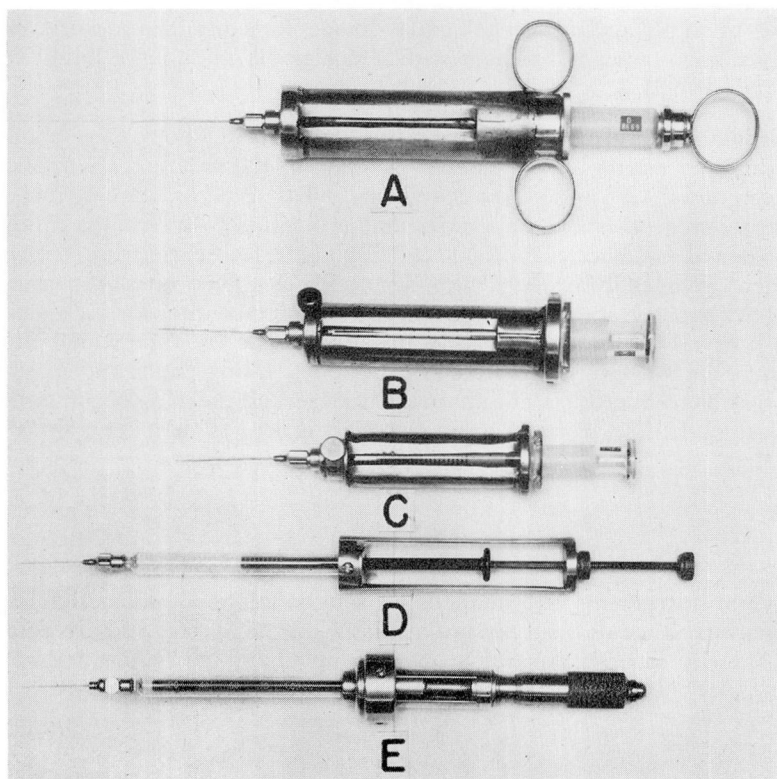

Fig. 4. Isotope syringes.

Intravenous Tracer Bottle Holder. The tracer bottle holder illustrated in figure 3, photograph and schematic drawing, has proved useful in the laboratory where large numbers of sterile isotope tracers are required. It consists of four lead protected partitions (2 by 4 by 8 inches) which hold four bottles. The bottles are placed upside down with the neck protruding through holes in the bottom lead plate and they are held in place by screw adjusters manipulated from the top. The front of the lead housing consists of a lead glass window 1 inch in thickness which permits a full view of the bottles and liquids and any manipulations therein. At the bottom of the stand is an adjustable automobile mirror which allows easy view of the rubber stoppers of the isotope bottles for insertion of the syringe needle. A fluorescent light furnishes adequate illumination for this procedure.

Isotope Syringes We have observed that syringes with lead shields of 5mm. thickness, as illustrated in figure 4 A, B, and C, permit quick loading and quick injection without being too bulky and heavy. The time of handling is thereby cut down to such an extent that the total exposure often is considerably below that of handling cumbersome syringes, notably when inserting the needle in the vein. Syringe D in figure 4 has an adjustable stop for the plunger which once set permits rapid metering of equal dosages for experimental work. Syringe 4E has a micrometer adjustment with which small amounts of liquid can be accurately expelled.

Disposable Equipment. In our Clinical Isotope Section where about 300 individual procedures are carried out per month, 100 of which are application of tracer doses, 120 uptake measurements, 40 treatments, and various other laboratory procedures, it is imperative that as much as possible of the equipment used to hold radioactive isotopes be disposable. Patients drink tracer and treatment isotopes from paper cups. Urine for clearance rates is measured in calibrated paper graduates or cups and the dipping counter for such measurements is covered with a thin readily available plastic test tube which after the measurement is disposed of with the paper cups. Using paper and plastics for such work has reduced to a minimum the disagreeable cleaning of contaminated glassware and the expense of these materials is far less than the gain in time and safety.

Conclusion

Several instruments and methods for safe handling of radioactive isotopes are discussed. Most of them are not available on the market and are described to aid those in the ever growing group of people handling radioactive isotopes.

Reference

1. e.g. *Safe Handling of Radioactive Isotopes*. Handbook 42, Department of Commerce, National Bureau of Standards, Washington, 1949.