

Cardiac prostheses: toward permanent implantation¹

Helen Kambic, M.S.
Shun Murabayashi, Ph.D.
Gordon Jacobs, M.S.
Raymond J. Kiraly, M.S.
Hiroaki Harasaki, M.D., Ph.D.
Leonard A. R. Golding, M.D.
Yukihiko Nosé, M.D., Ph.D.

The pneumatically actuated total artificial heart (TAH) can maintain normal physiology in man and in experimental animals for several months with extracorporeal pneumatic actuation through the skin. The ultimate goal is the development of a totally implantable cardiac prosthesis that functions for a minimum of two years. The Cleveland Clinic Foundation's cardiac prosthesis is a pusher-plate type of blood pump that uses protein-coated blood contact surfaces and trileaflet dura mater valves. The pusher-plate design for mechanical actuation provides a net stroke volume of 80 ml. It can pump as much as 9.6 L/min at 120 beats/min with 15 mm Hg inlet pressure. Total artificial hearts and the left ventricular assist devices (LVAD) were implanted in calves without anticoagulation for as long as seven months. Our group is developing a mechanically actuated universal blood pump for use as a TAH and LVAD, compatible with either thermal or electrical actuation systems. We have also developed a parathoracic version of the LVAD. The application of newly developed implantable actuation systems to cardiac prostheses offers many alternatives to the traditional pneumatic method. These methods should allow the patient to live a nearly normal life. We summarize the recent work in this area and identify the relevant design features and mechanical actuation systems for cardiac prostheses.

Index terms: Artificial organs • Biocompatible materials • Heart, artificial • Heart, mechanical • Prosthesis, cardiac

Cleve Clin Q 51: 105–117, Spring 1984

¹ Departments of Artificial Organs (H.K., S.M., G.J., R.J.K., H.H., Y.N.) and Thoracic and Cardiovascular Surgery (L.A.R.G.), The Cleveland Clinic Foundation. Submitted for publication Aug 1983; revision accepted Sept 1983.

This work was supported by NIH Grant No. HL-24286 (1979), NIH Contracts N01-HV-02911 (1980), N01-HV-28001 (1982), N01-HV-28002 (1982), and N01-HV-1-2906 (1981).

Biomaterials are the basis for the construction of all artificial organs, whether they are made from totally synthetic materials or fabricated from specially treated natural tissues. The development of cardiovascular materials has

been hampered by the lack of satisfactory materials of sufficient durability and strength. Requirements for biomaterials vary significantly depending on duration of use, intended method of application, and function¹ (Table 1). Blood compatibility of materials is the most important consideration, even in transient applications.

No single material has yet fulfilled all requirements for blood compatibility and mechanical durability for use in cardiac devices. Two approaches have been directed to the development of surfaces, which either (1) form blood linings [(pseudoneointima (PNI)] or (2) minimize cellular or protein reactions. For short-term or interim (two weeks to one month) use of LVADs, both approaches appear equally advantageous.²

Certain types of smooth surfaces are believed not to activate the blood coagulation system. Silicone-based elastomers, polyurethanes, pyrolytic carbons, polyethylene, Biomer, Avcothane 51, and other relatively new synthetic polymers have shown good blood compatibility. In general, the advantages of these smooth elastomers alone or in combination with special surface treatment are minimal thrombosis and fibrin deposition. Anticoagulation may be required. In long-term implantation, calcification occurs on both smooth and rough materials. Calcified deposits are seen preferentially in the stress concentration areas of the moving diaphragm. Location of the calcified deposits also coincides with the loci of surface imperfections or surface defects.³ It has been suggested that degenerative changes in the bulk structure and surface properties of long-term mechanically active polymers may account for diminished functions or complete failure of the device.⁴

Rough surfaces, such as those typically found in textured materials, such as woven Dacrons, polytetrafluoroethylene (PTFE) knitted velours,

and texturized metal materials, generate PNI formation. These strongly adherent biologically derived linings require anticoagulation to control layer thickness. Pseudoneointimal linings on blood pump bladders perform as stable biological linings derived first from the deposition of circulating blood elements and the formation of an organized fibrin matrix. With time, cellular proliferation is seen, and in situ collagen synthesis may be observed.⁵ The disadvantage of these materials is the possibility of emboli originating from their surface or calcification of the layer, leading to a loss of compliance.⁶ Using this concept, several laboratories have introduced cell-seeding techniques. Cultured endothelial cells and bovine fetal cells are being used to accelerate the development of a thin organized cellular interface.^{7,8} The formation of pseudoneointimal linings composed of native collagen is considered highly desirable by some, since it represents an end stage in the intravascular healing process.⁹

Biolized surfaces

We have attempted to develop a smooth, biolized gelatin surface for all blood-contacting areas of the blood pumps.¹⁰ Smooth glutaraldehyde-treated gelatin coatings on blood pumps implanted in calves for up to seven months without anticoagulants did not elicit PNI formation and showed excellent blood compatibility without any signs of biodegradation.¹¹

Our laboratory has accumulated considerable experimental data in recent years regarding the characteristics of biolized materials for cardiac prosthesis.^{12,13} Biologically derived chemically treated natural materials, such as glutaraldehyde-treated pericardium and glutaraldehyde-treated gelatin, are termed "biolized" materials.

The term "biolization" was conceived in the laboratories of the Department of Artificial Organs of The Cleveland Clinic Foundation (CCF) in 1971^{14,15} and has since been used to refer to either the chemical or thermal treatment of natural tissue or protein (natural tissue derivatives) by either coating or blending protein with other polymers.

The hypothetical process for the production of biocompatible and blood-compatible materials is illustrated in Figure 1.¹⁴ The materials could be either natural or artificial in origin, but must contain protein, polysaccharide, or other biological components. Synthetic polymers could be

Table 1. Classification of biomaterials

A. Intended period of use or application
1. Permanent
2. Long-term
3. Transient
B. Intended method of application
1. Reconstruction and augmentation of tissues and organs (spare parts, e.g., heart valves)
2. Reconstruction and augmentation of physiological function, e.g., cardiac prosthesis, dialysis
C. Function
1. Passive—structural components
2. Active—moving structure

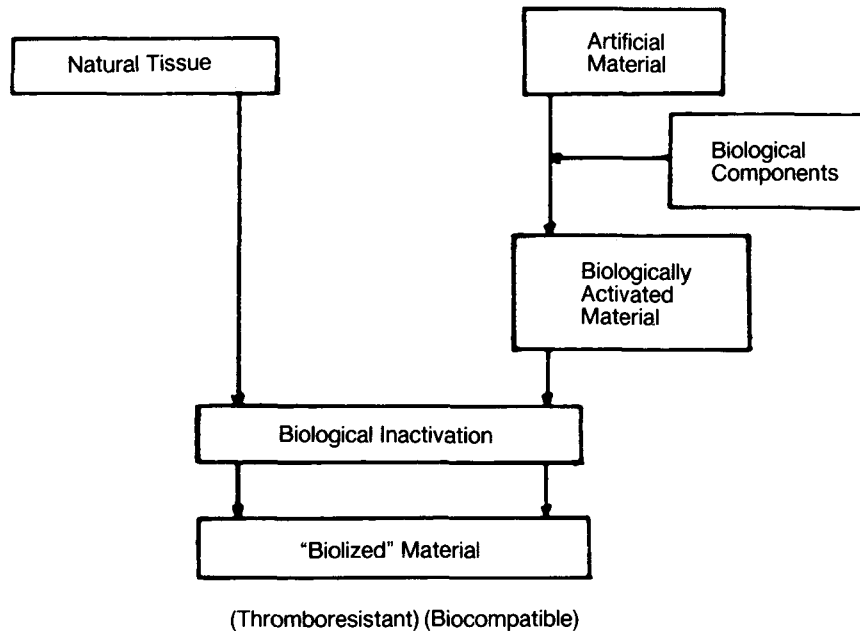

"BIOLIZATION", HYPOTHETICAL PROCESS TO GENERATE BIOCOMPATIBLE MATERIAL

Fig. 1. Biolization, the hypothetical process that generates biocompatible material.

conditioned either by blending with biological components or by coating them (biological activation). We hypothesized that blood-compatible surfaces can be created by the use of surface protein and/or polysaccharides in their inactivated form. A surface treated with heat or aldehyde becomes "biologically inactivated," which is the denaturation, insolubilization, or cross-linking of biological components. As a result of these findings, it was conceived that extracting proteins or other biological components from natural tissue and blending them with synthetic polymers would improve the blood compatibility of the polymer. This concept affords the versatility of selecting polymers based on physical properties for a given application, rather than restriction to the use of only natural tissue or to a narrow range of available medical polymers. The "biologically activated polymer" is aldehyde treated in a solid state to produce a biolized polymer.

Types of cardiac prostheses

In 1964 the National Heart Lung and Blood Institute (NHLBI) initiated the NHLBI heart program with the overall goal of developing devices that could be used effectively to rehabilitate patients with advanced heart disease.¹⁶ Research was focused on temporary left heart assist sys-

tems, permanent (2–5 years) left heart assist systems and the total artificial heart (TAH). Different types of prostheses can fulfill different clinical needs and therefore require different criteria for clinical use and development.¹⁷ The basic considerations related to device development are outlined in *Table 2*. *Table 3* summarizes cardiac prostheses in terms of potential applications and intended period of use.

Pump design and fabrication

The Cleveland Clinic Foundation left ventricular assist device

The major design objective of the LVAD for temporary use is the complete unloading of the left ventricle with total capture of cardiac output. Mechanical support of the failing heart and circulation must function to (1) decrease cardiac work, (2) increase systemic perfusion, and (3) increase the myocardial oxygen supply/demand ratio. For permanent use, the LVAD would maintain a near normal systemic circulation. To satisfy these demands, the current left ventricular assist pump for both temporary and permanent application was designed specifically for human implantation.¹⁸ This pusher-plate pump was designed for use with a mechanical actuation system. The pump is 11 cm in diameter and 3 cm

Table 2. Basic blood pump design considerations related to device development

A. Blood surface interactions
1. Cellular
2. Physicochemical
3. Rheological
B. Material durability
1. Material selection
2. Design
3. Fabrication
4. Pump geometry
5. Shelf life
6. Sterilization
C. Actuation
1. Pneumatic
2. Hydraulic
3. Mechanical
D. Power source
1. Electric
2. Thermal
E. Placement
1. Intrathoracical
2. Parathoracical
3. Extracorporeal
4. Abdominal
F. Size and weight
G. Mode of pumping
1. Nonpulsatile
a. Roller pump
b. Centrifugal pump
2. Pulsatile
a. Pusher-plate pump
b. Sac type pump

thick, providing a net stroke volume of 80 ml through a pusher-plate displacement of 1.5 cm (Fig. 2). It is capable of pumping up to 9.6 L/min at 120 beats/min with 15 mm Hg inlet pressure. A major consideration was the exact location of the pump in the body. For best conformance to anatomical constraints, the pump, the most reliable component, was placed intrathoracically and the actuator was placed parathoracically. The ribs would protect all vascular

connections. The pump would be close to the natural heart to provide maximum efficiency, effectiveness, and minimal orientation effects on filling. Blood is obtained from the left ventricular apex and returned to the descending thoracic aorta (Fig. 3). The pump geometry and placement inside the chest were arrived at by detailed anatomy studies using computerized axial tomography,¹⁹ angiography, conventional radiography, and anatomical measurements of living patients. The pump was designed to fit the curvature of the left lateral thoracic wall to minimize lung displacement and avoid compression of the major vessels and pulmonary hilus. Space for the actuator is created by removal of the 6th or 7th rib to allow use of the rib space together with the subcutaneous location (Fig. 3).

To actuate the pusher-plate mechanically, a simple interim method of actuation was needed during the early phase of development. A pneumatic cylinder appeared simplest since existing pneumatic drive systems could be used with slight modifications for high-pressure operation. A small pneumatic actuator was designed and fabricated for subsequent testing. The actuator provides positive displacement of the pusher-plate shaft only in the systolic direction. In diastole, the actuator shaft is retracted, allowing the pusher-plate shaft to return at its own rate. Thus, filling is completely passive, with no vacuum or mechanical assistance applied to the pusher-plate or diaphragm during diastole. This closely simulates how the electrical energy converter would operate with the pump. Figure 4 is a cross-section drawing of the pump with the pneumatic actuator used in testing. The main components of the blood pump include the cast epoxy outer and inner housings, polyolefin rubber diaphragm, and the pneumatic actuator.

To mechanically anchor the biolized coating on both the pump housing and diaphragm, the

Table 3. Applications of cardiac prosthesis

Type	Function	Device	Duration	Features
1. Transient	Temporary support of the failing heart	Intraaortic balloon pump (IABP) Cardiopulmonary bypass Temporary LVAD	Days—weeks (2)	Readily available and easily removed
2. Interim	Support patient awaiting transplantation	Biventricular bypass pump LVAD Biventricular bypass pump TAH	≤ one month	Readily available and easily removed
3. Permanent	Total support of the circulation	TAH LVAD	≥2 years	Totally implantable

LVAD = left ventricular assist device, TAH = total artificial heart.

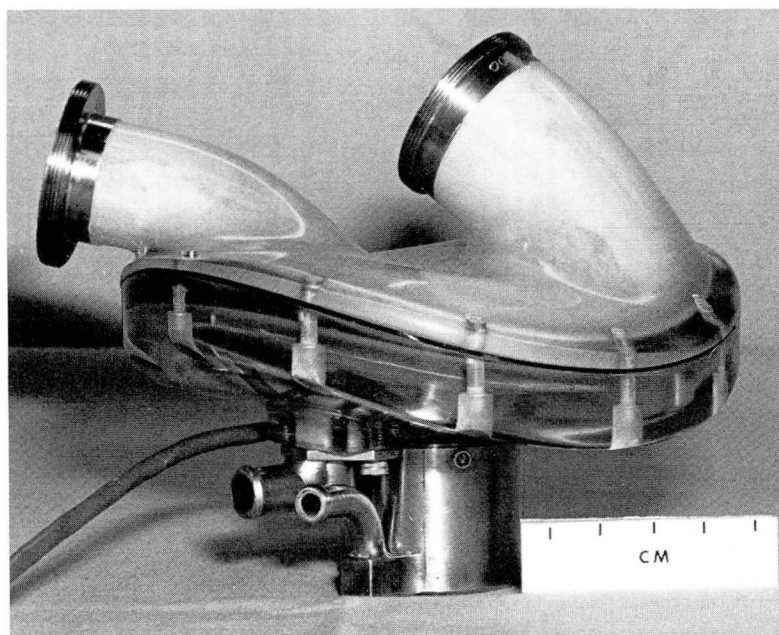

Fig. 2. The Cleveland Clinic Foundation left ventricular assist device (LVAD). This pneumatic pusher-plate LVAD has been used in animals for as long as seven months and is being used clinically as a temporary assist device. The pump is equipped with an epoxy housing, a polyolefin rubber diaphragm, and is coated internally with aldehyde-treated gelatin. Dura mater valves are used in the inflow and outflow ports of the housing. The pneumatic actuator is located below the pump in this photograph.

surfaces must be textured. The diaphragm surface was integrally textured with the use of a salt casting technique after compression molding.²⁰ The pump housing surface is coated with a textured layer of polyurethane (Avcomat 610), with the use of a similar technique. The resulting surface texture is nominally 100 μm thick with open pores nominally 20 μm in diameter (*Fig. 5*). After final assembly, biolization is done by dipping the entire pump in a gelatin solution with the use of vacuum to fill the pores in the textured surfaces, and then crosslinking the gelatin coating in place with glutaraldehyde. By coating the pump after assembly, the entire blood contact surface is seamless, with no discontinuities. With gelatin impregnated into the pores, additional coatings provide a smooth surface for blood contact.²¹ This biolized surface, combined with the natural tissue valves fabricated from human dura mater, eliminates the need for anticoagulants.

Six implants were done to evaluate long-term biocompatibility and performance. The experiments in this series ranged from three to seven months. All experiments were terminated electively. Results revealed that the biolized pumps were all generally clean even in the presence of infection (*Fig. 6*).

Total artificial heart development

The pusher-plate type blood pump has also been used for the TAH. The design of this pump has evolved directly from the LVAD pump. For the TAH, two pusher-plate pumps are used to replace the right and left ventricles of the natural heart. The dimensions of the pumps are similar to those of the LVAD; however, the TAH pumps are in a flat rather than curved configuration and the blood ports have been changed to accommodate the arterial and atrial connections. Actuation of the pumps is provided by the same pneumatic actuators as those used in the LVAD system. Although this design has not been finalized to accommodate human configuration, it allows testing of the device and various control methods. This device has been implanted for as long as 108 days in calves, during which various control methods were evaluated.^{22, 23}

A magnetic (Hall-effect) position sensor and a new electronic control system allow each pump to be operated at a constant stroke volume and a variable rate. Both the right and left pumps can run independently with rates set by both filling pressure and afterload, synchronously with either the left or the right being the master or slave, or

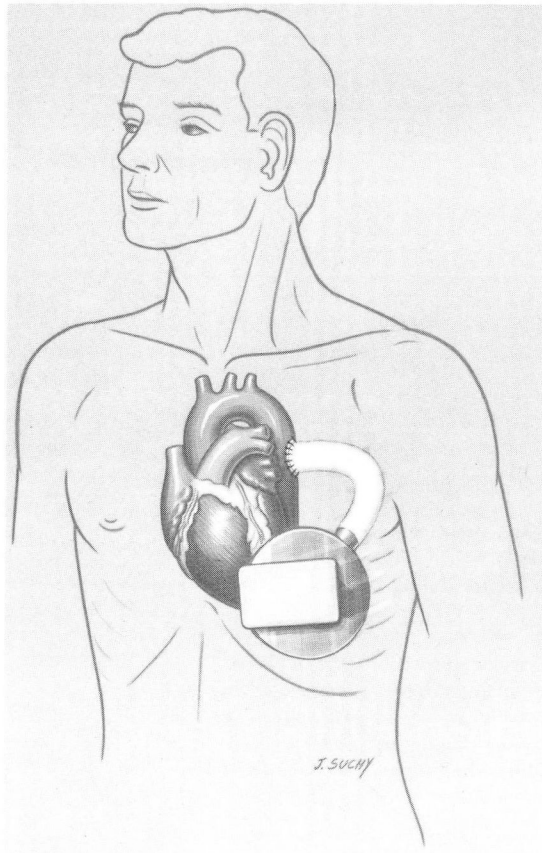

Fig. 3. Model showing the clinical configuration of the blood pump integrated with the electrical energy system. Since the parathoracic energy converter is modular and accessible by simple skin incision, the entire power system can be replaced without entering the thorax or disturbing the blood-contacting components.

in an alternate beating mode with either pump setting the rate. No invasive feedbacks, such as atrial or arterial pressure monitorings are used, unlike other groups.²⁴ Preliminary results indicate that this system can provide more physiological hemodynamics than previous types of pumps. The permanently implantable cardiac prostheses will be composed of two pusher-plate pumps combined with an energy conversion system.

Compliance chamber development

A totally implantable LVAD would be a "closed" system. The actuation system and blood pump are contained within the body with no direct communication to the outside. In displacement-type pumps, the nonblood side of the pump undergoes a volume change equal and opposite to that of the blood side. In a closed system this volume must be accommodated. A compensator under study includes a highly compliant chamber open to the back of the pusher plate. Fluid is shuttled back and forth from the back side of the pump to the compliance chamber located elsewhere in the body (Fig. 7.)

The basic design of the compliance chamber consists of a titanium backplate curved to fit the inside of the rib cage and a flexing diaphragm that faces the lung, which can be inflated to 150 ml with negligible pressure. Our first attempts in designing this compliance chamber utilized smooth flexing surfaces.²⁵

Our latest studies show that a Dacron-velour-

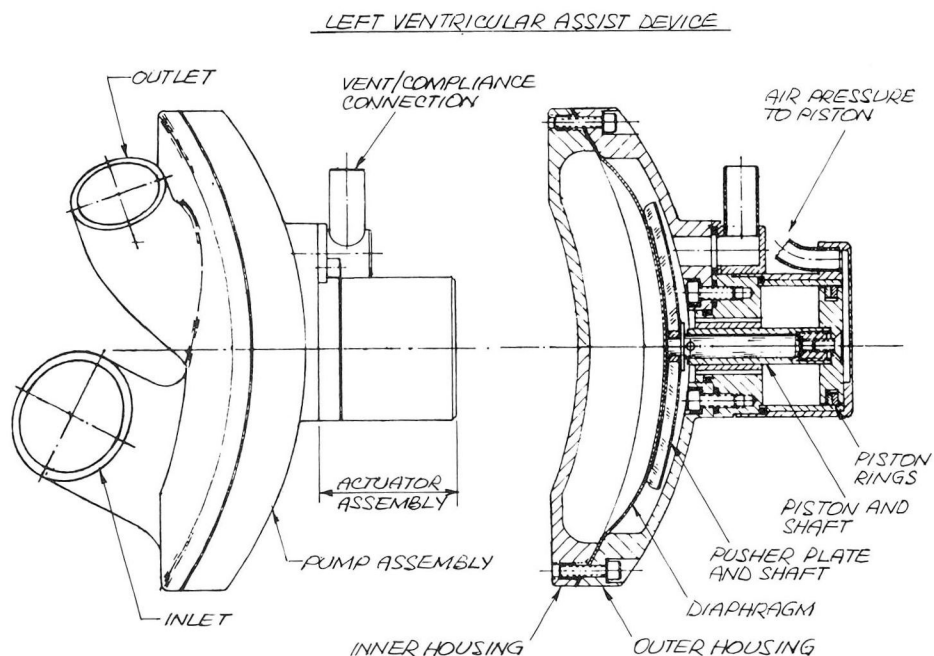

Fig. 4. Drawing of the left ventricular assist device assembly with housing and attached pneumatic actuator.

SALT CAST TECHNIQUE FOR TEXTURING SURFACE

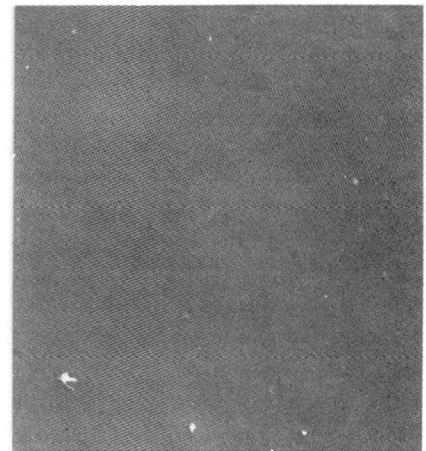
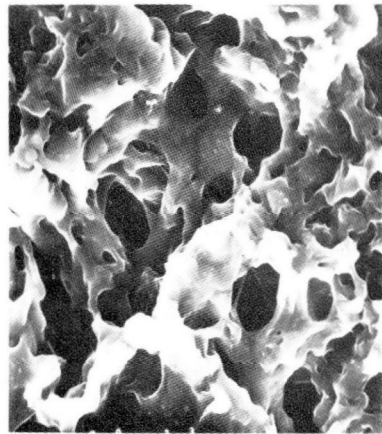
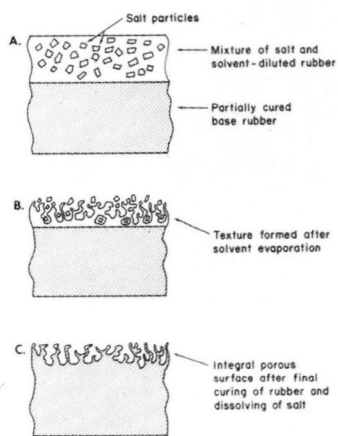

Fig. 5. Salt cast technique for texturing the polyolefin rubber diaphragm surface before the application of gelatin; (*center*) control-textured polyolefin rubber; *right* $\times 1000$, smooth surface obtained after the application of the biolized gelatin coating.

textured surface²⁶ has outperformed the smooth surface used previously and increased device duration and performance. This textured series of compliance chambers, which has been functioning for more than two years, appears promising for totally implantable blood pump systems.

Implantable left ventricular assist device and energy conversion systems

Table 4 describes the blood pumps and the energy converter systems currently undergoing development and evaluation by our laboratory.



4 months



5 months

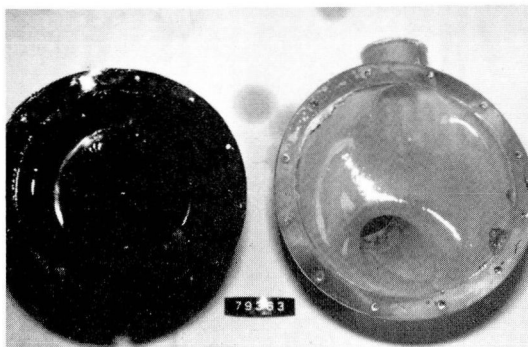

6 months

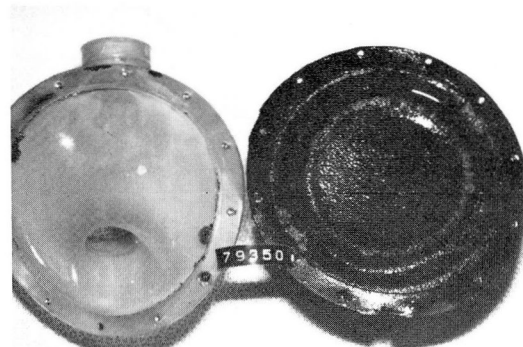

7 months

Fig. 6. Appearance of the blood-contacting surface of the pusher-plate left ventricular assist device pumps coated with gelatin after implantation in calves for four to seven months, respectively. Housing and diaphragm are clean without thrombus.

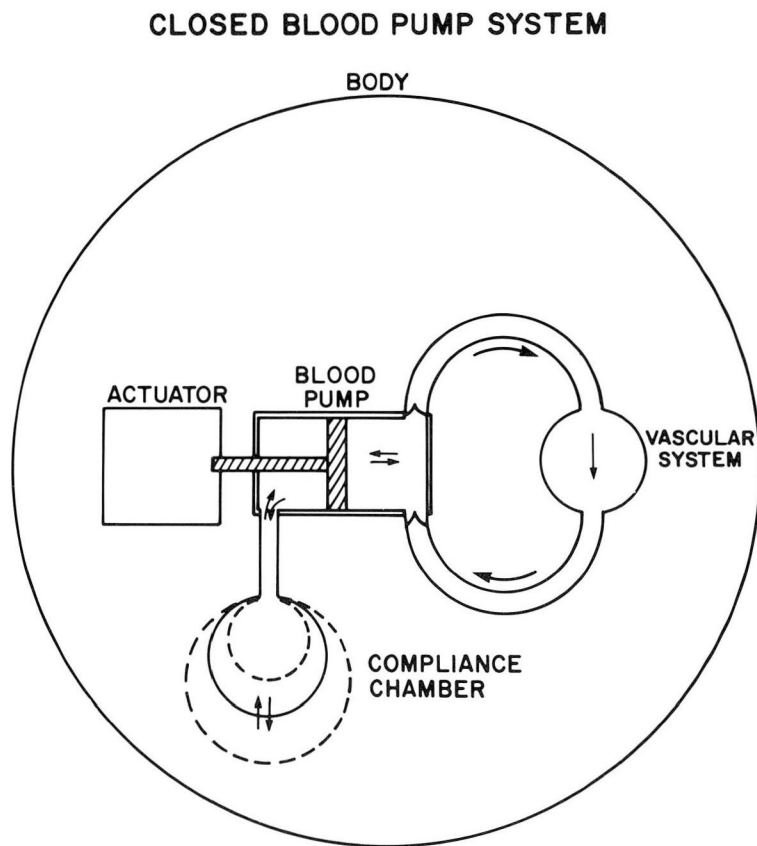

Fig. 7. Schematic of the compliance chamber required for the closed system left ventricular assist device. Both actuation system and blood pump are contained within the body with no direct communication to the outside.

Table 4. Experimental LVAD and coordinated implantable energy conversion systems

Blood pump/converter	Description	Blood pump material interface	Pump flow capacity	Actuation	Actuator weight/volume	Implantation site
1. CCF LVAD/Nimbus	Pusher plate diaphragm pump; brushless DC motor	Smooth aldehyde-treated gelatin coated on textured polyurethane and polyolefin rubber	9.6 L/min	Electrohydraulic	0.35 kg/183 cc	Intrathoracic left ventricular apex to descending aorta
	High-speed, motor-driven gear pump pressurizes hydraulic fluid to produce force on actuator piston which moves pusher plate					
2. CCF LVAD; Nimbus	Pusher-plate diaphragm pump	Same as above	9.6 L/min	Thermal-pneumatic	0.99 kg/430 cc	Intrathoracic left ventricular apex to descending aorta
	Engine generates high pressure fluid which drives blood pump					
3. Thermo Electron PVAD model; JCGS Stirling Cycle Engine	Pusher-plate diaphragm pump	Textured powdered metal housing Polyester flock diaphragm	11.5 L/min	Thermal-hydraulic	0.93 kg/410 cc	Parathoracic left ventricular apex to descending thoracic aorta
	Engine generates high pressure fluid which drives blood pump					

LVAD = left ventricular assist device, PVAD = parathoracic ventricular assist device, JCGS = Joint Center for Graduate Study, University of Washington, Richland, WA.

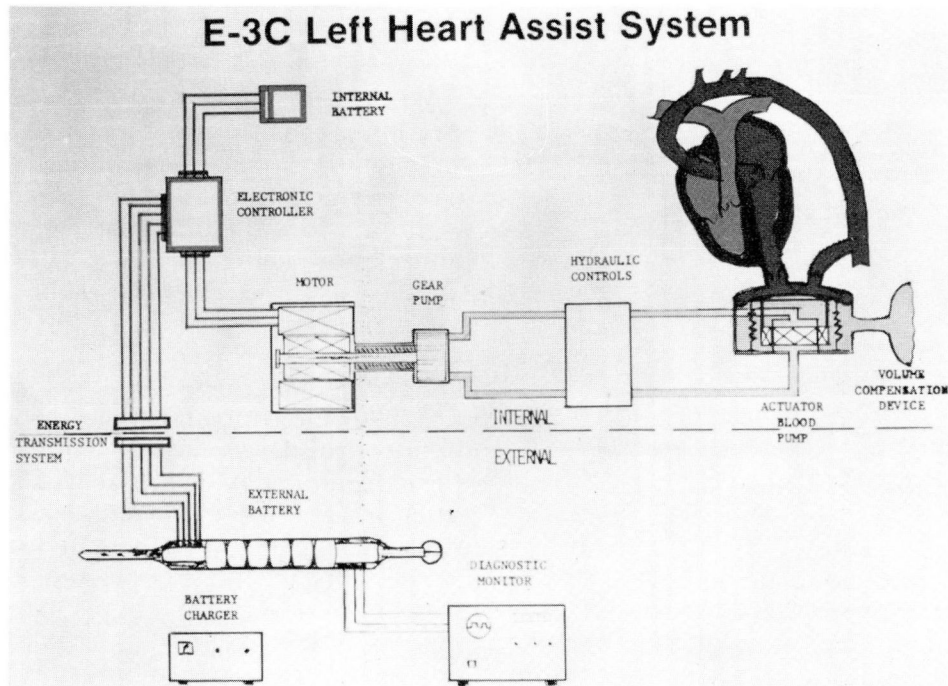

Fig. 8. Schematic of the complete CCF/Nimbus system composed of the combination of external components worn by the patient, implanted blood pump and energy system, and separate exterior support equipment.

Three permanently implantable left ventricular assist systems (LVAS) are being developed. The CCF biolized blood pump is being adapted for use in two energy conversion systems, one electrical and one thermal. The third LVAS system combines a parathoracic ventricular assist device (PVAD) with another thermal energy converter.

Electrohydraulic Systems: Cleveland Clinic Foundation/Nimbus

The CCF/Nimbus (Nimbus Incorporated, Rancho Cordova, CA) system is comprised of a combination of external components worn by the patient, implanted components, and separate support equipment (Fig. 8). Externally, the patient wears the main power source; a battery is incorporated into a vest or belt pack. Implanted components provide blood pumping and synchronization control and include a limited-capacity battery for maintaining operation without external power. Support equipment functions include battery charging and processing and interpretation of diagnostic data. Specific components comprising this concept and being developed as part of the electrohydraulic system include the following: the (1) blood pump, (2) energy converter, (3) variable volume device, (4) internal battery, (5) wiring harness, (6) energy transmission de-

vice, (7) external battery, (8) battery charger, and (9) diagnostic signal monitor.^{27, 28} Figure 9 shows the integrated electrohydraulic system and blood pump.

This electric version of the LVAS uses a high speed, continuous running motor that drives a hydraulic gear pump. For maximum efficiency,

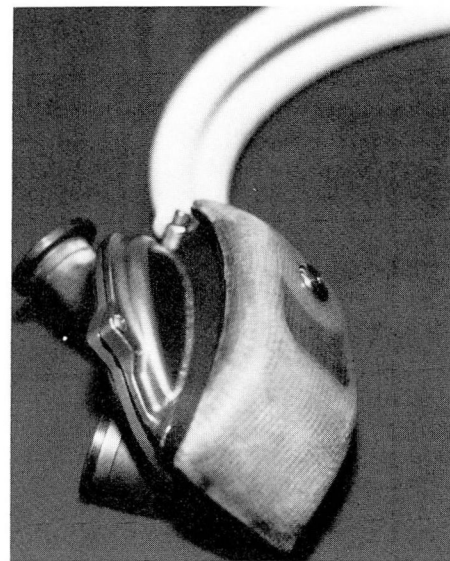

Fig. 9. Integrated CCF/Nimbus left ventricular assist system. The clinical blood pump is machined from titanium.

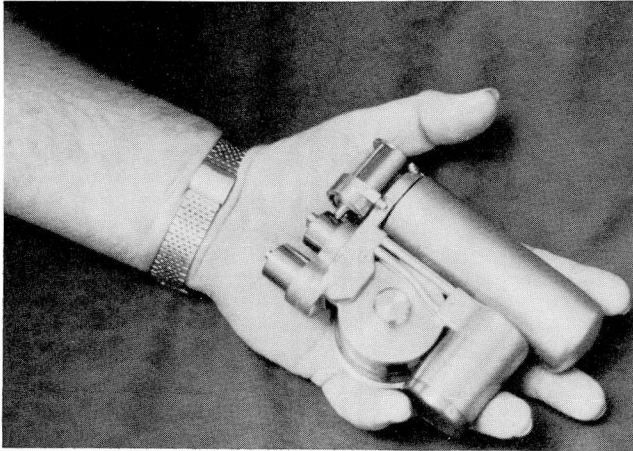

Fig. 10. Current developmental Nimbus MK-9 thermal energy conversion system.

the electric controls modulate motor speed in response to varying physiological demands.

The internal battery unit is in the thoracic region, which maintains assist system operation in the event of loss of power from the external source. Multiple nickel cadmium cells contained in titanium housings provide operation capability for approximately 30 minutes. Thus, the patient can be completely free of external components for a limited period of time. With this assist device, electrical power and signals must be transmitted across the intact skin by inductive coupling of an external primary coil and an implanted secondary coil. In vivo experiments with the integrated blood pump and electrohydraulic energy system show good function, control, and synchronization.

Thermal ventricular assist systems

1. Cleveland Clinic Foundation/Nimbus

A fully implantable thermal type energy converter for LVADs was initiated by Nimbus, Incorporated through collaboration with CCF. The main components of the thermal LVAS are an engine, actuator, pneumatic controls, blood pump, and cooling system.²⁹ The CCF biolized LVAD will be used as the blood pump in this system. The basic concept of the thermal power systems involves the conversion of heat to pneumatic power and the subsequent use of this power to actuate and control the blood pump. The flow of pressurized helium gas from a regenerated thermocompressor engine drives a blood pump actuator. The use of helium as a working fluid provides an inert environment for the internal components of the system and eliminates the need for intermediate energy conversion components. The current Nimbus MK-9 thermal engine operates as a gas compressor, using a modification of the Stirling thermodynamic cycle, and provides the helium flow rate and pressure to the actuator and pneumatic controls (*Fig. 10*). The components and a schematic illustration of the system circuit are shown in *Figure 11*. Energy for the system can be obtained from either a radioisotope or a periodically heated thermal salt, using the heat of fusion to store energy. The MK-9 engine is being designed for a 14-watt heat source, and features hermetically sealed modular components, titanium for external surfaces, the elimination of intermediate energy conversion devices, and reduction in overall engine size.

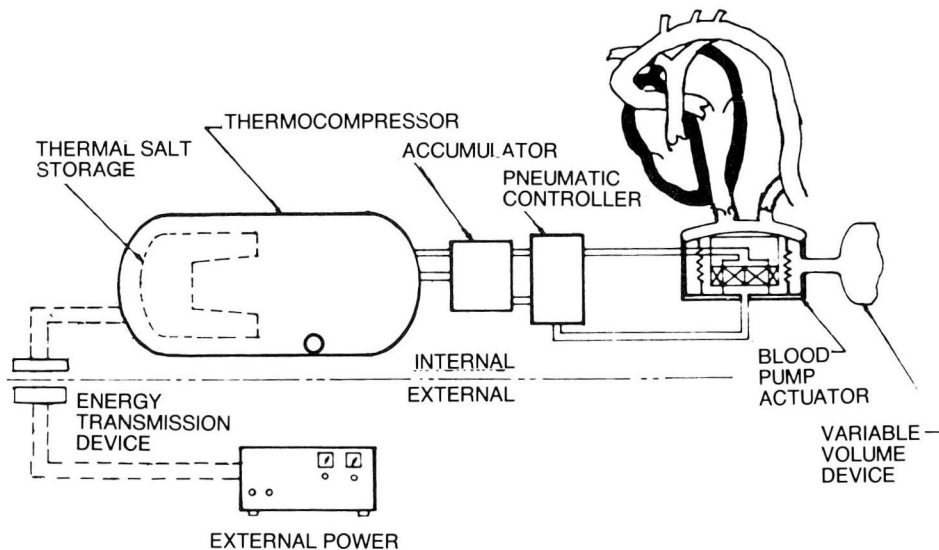

Fig. 11. Schematic showing the primary components of the Nimbus thermal LVAD concept.

The pneumatic energy supplied by the engine is directed to the actuator piston by means of the pneumatic control logic. The actuator force is transmitted by means of a linear magnetic coupling to a magnet assembly attached to the pusher plate. A compression spring is also coupled to the pusher plate to alternately store energy during blood-pump filling and contribute energy during ejection. The blood is the heat sink for the waste heat from the engine. In vitro testing of the engine and system components for endurance is continuing. An initial implant of the Nimbus system in calves was terminated after 23 days because of infection.

Joint Center for Graduate Study/Thermo Electron Corporation/

2. The Cleveland Clinic Foundation

The second approach to developing a thermal ventricular assist device (TVAS) is a system coordinated through the efforts of the Joint Center for Graduate Study (JCGS) at the University of Washington, Richland, WA, the Thermo Electron Corporation (TECO) Waltham, MA, and CCF.

The objective of the JCGS thermal energy system development is to obtain a clinically useful, permanently implantable Stirling/hydraulic system to operate a LVAD blood pump.³⁰

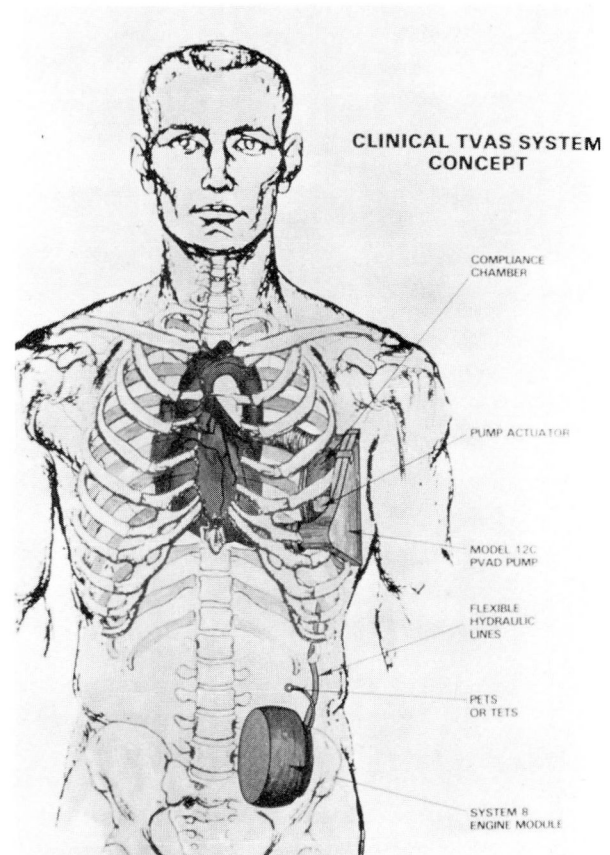

Fig. 12. Thermal ventricular assist system. The completely implantable clinical prototype will be available for animal testing in 1984.

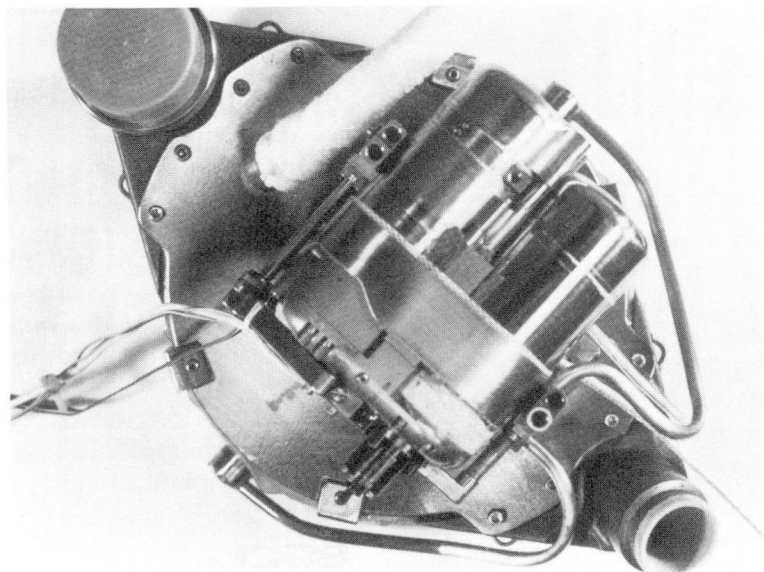

Fig. 13. Integrated thermal left ventricular assist device system. The System 7 thermal engine is mounted on the parathoracic ventricular assist device blood pump. This version of the thermal ventricular assist pump is being tested in animals.

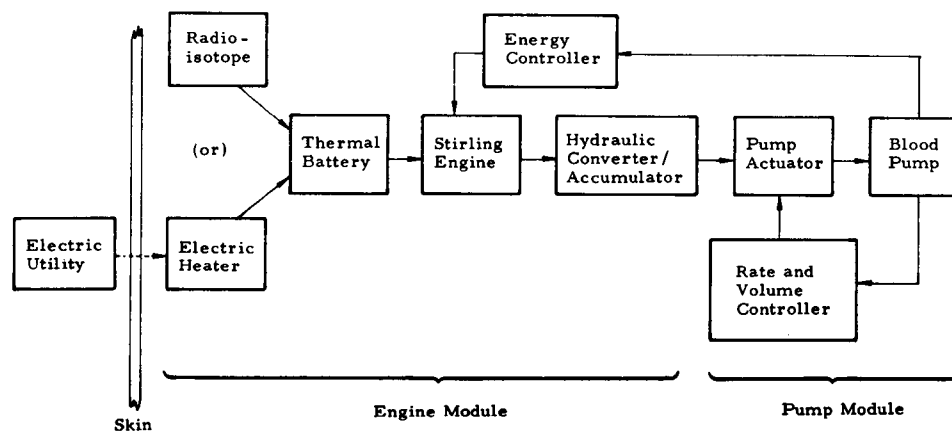

Fig. 14. Block diagram showing the major components of the JCGS-7 system (Joint Center for Graduate Study, University of Washington, Richland, WA).

TECO and CCF began development of the parathoracic ventricular assist device in 1975.^{31,32} This pump was designed for developmental purposes to be implanted in a parathoracic location in calves with the main pump body outside of the thoracic wall but under the skin and muscles. The inflow and outflow ports pass through the thoracic wall, in the space left by the removal of one rib, and connect by conduits to the left ventricle and descending aorta. The thermal system designed for human implantation (Fig. 12) has an integrated heat exchanger that allows for dissipation of heat into the blood passing through the pump.

The present TVAS (System 7) consists of the JCGS-7 energy converter mounted directly on the inner cover (adjacent to the lung when implanted) of the blood pump (Fig. 13). The JCGS energy system is schematically outlined in Figure 14. Heat produced by an electric heater (or internal radioisotope source) is stored in a thermal battery until required by the Stirling engine. The engine produces pneumatic power, which is converted to hydraulic power and then stored in an accumulator for use by the blood-pump actuator. Hydraulic logic regulates the engine speed and limits power requirements of the engine to only that required by the natural heart. The pump actuator/controller hydraulic logic is sensitive to the blood-pump filling rate and volume and is programmed to operate the blood pump in synchronous counterpulsation with the natural heart. In the present configuration, the engine, actuator, and pump are all closely coupled, but it is possible to separate the engine and actuator and connect them via flexible hydraulic lines.

The hydraulic oil carries the waste heat from the engine to the heat exchanger on the blood pumps.

In vivo evaluations of System 7 have been rather limited as yet, but during the few short-term tests that have been conducted, TVAS 7 has been capable of providing over 10 L/min blood flow, and fully synchronous beat-for-beat operation was obtained at rates ≤ 144 beats/min.

Summary

The acceptance of a clinically implantable blood pump system with a two-year-period of intended use has become a realistic goal. The feasibility and physiological effectiveness of these devices to provide continuous circulatory support has been effectively demonstrated with pneumatically actuated systems. Acceptable in vivo system performance has been achieved in terms of material durability, mechanical control, and hemodynamic response to physiological needs. This achievement has been possible through continuous improvements in pump design, biomaterials, control and driving systems, and collaborative team efforts. Totally implantable blood pumps offer the patient greater opportunities for a more normal life style. In a number of selected clinical areas the LVAD would serve as a method of choice for the long-term treatment of inoperative cardiac failure and the TAH as an alternative to cardiac transplantation.

References

1. Murabayashi S, Kambic H, Nose Y. Clinical benefits and needs attributed to biomaterials. [In] Boretos J, Eden M, eds. Introduction of Biomaterials to Clinical Care. Park Ridge, New Jersey, Noyes Publications, 1984 (in press).

2. Kolff WJ, Stellwag F. Blood at artificial organ surfaces: progress to date as stepping-stones for the future. *Ann NY Acad Sci* 1977; **283**:443-456.
3. Coleman D, Andrade JD, Kolff WJ. Calcification of long term artificial heart implants. *Abstracts ASAIO* 1979; **8**:23.
4. Harasaki H, Gerrity R, Kiraly R, Jacobs G, Nosé Y. Calcification in blood pumps. *Trans Am Soc Artif Intern Organs* 1979; **25**:305-310.
5. Turner S, Bosart M, Clay W, Frazer O. Pseudoneointimal analysis of chronically implanted blood pumps. [In] Szycher M, ed. *Biocompatible Polymers, Metals and Composites*. Westport CT. Technomic Publishing Co, 1983, pp 213-237.
6. Bernhard WF, LaFarge CG, Liss RH, Szycher M, Berger RL, Poirier V. An appraisal of blood trauma and blood-prosthetic interface during left ventricular bypass in the calf and humans. *Ann Thorac Surg* 1978; **26**:427-437.
7. Eskin SG, Sybers HD, Trevino L. Thromboresistant surfaces of tissue cultured endothelial cells. *Scan Electron Microsc* 1978; **2**:747-754.
8. Mansfield PB, Wechezak AR, Sauvage LR. Preventing thrombus on artificial vascular surfaces: true endothelial cell linings. *Trans Am Soc Artif Intern Organs* 1975; **21**:264-272.
9. Szycher M, Bernhard WF. Hemocompatible interfaces in artificial heart devices. [In] Szycher M, ed. *Biocompatible Polymers, Metals and Composites*. Westport CT, Technomic Publishing Co, 1983, 103-163.
10. Kambic H, Picha G, Kiraly R, Koshino I, Nosé Y. Application of aldehyde treatments to cardiovascular devices. *Trans Am Soc Artif Intern Organs* 1976; **22**:664-672.
11. Harasaki H, Kambic H, Whalen R, et al. Comparative study of flocked vs. biolized surface for long-term assist pumps. *Trans Am Soc Artif Intern Organs* 1980; **26**:470-474.
12. Kambic H, Barenburg S, Harasaki H, Gibbons D, Kiraly R, Nosé Y. Glutaraldehyde-protein complexes as blood compatible coatings. *Trans Am Soc Artif Intern Organs* 1978; **24**:426-438.
13. Kambic H, Murabayashi S, Harasaki H, et al. Composite polymeric materials. Evaluation of crosslinked gel protein surfaces. *Artif Organs* 1979; **3**(suppl):203-221.
14. Nosé Y, Tajima K, Imai Y, et al. Artificial heart constructed with biological material. *Trans Am Soc Artif Intern Organs* 1971; **17**:482-489.
15. Imai Y, Tajima K, Nosé Y. Biolized materials for cardiovascular prosthesis. *Trans Am Soc Artif Intern Organs* 1971; **17**:6-9.
16. Altieri FD. Status of implantable energy systems to actuate and control ventricular assist devices. *Artif Organs* 1983; **7**:5-20.
17. Nosé Y, Murabayashi G, Jacobs G, Kiraly R. From transient circulatory assistance to total heart replacement. *Jap J Artif Organs* 1983; **12**:757-760.
18. Ozawa K, Snow J, Sukalac R, et al. Totally implantable left ventricular assist device for human application. *Trans Am Soc Artif Intern Organs* 1980; **26**:461-465.
19. Jacobs GB, Agishi T, Ecker R, Meany T, Kiraly RJ, Nosé Y. Human thoracic anatomy relevant to implantable artificial hearts. *Artif Organs* 1978; **2**:64-82.
20. Kiraly RJ, Arconti R, Hillegass D, Harasaki H, Nosé Y. High flex rubber for blood pump diaphragms. *Trans Am Soc Artif Intern Organs* 1977; **23**:127-133.
21. Murabayashi S, Sukalac R, Harasaki H, et al. Biolized intrathoracic left ventricular assist device for chronic human use. *Org Coatings Plas Chem* 1980; **42**:477.
22. Harasaki H, Takatani S, Suwa S, et al. Hemodynamic regulation in total artificial heart recipients. *Artif Organs* 1981; **5**:38-45.
23. Takatani S, Harasaki H, Suwa S, et al. Pusher-plate type TAH system operated in the left and right free-running variable rate mode. *Artif Organs* 1981; **5**:132-142.
24. Norman JC. Development and evaluation of a long term low profile intracorporeal (abdominal) left ventricular assist device. (THI E-type LVAD). Final Report to NHLBI Contract N01-HV-7-2936, 1977-1980, Oct.
25. Snow J, Harasaki H, Kiraly R, Whalen R, Nosé Y. Feasibility of thoracic compliance chambers for pulsatile blood pumps. *Artif Organs* 1979; **3**(suppl):299-305.
26. Snow J, Harasaki H, Kasick J, Whalen R, Kiraly R, Nosé Y. Promising results with a new textured surface intrathoracic variable volume device for LVAS. *Trans Am Soc Artif Intern Organs* 1981; **27**:485-489.
27. Butler K, et al. Development of an implantable electrohydraulic left heart assist system. Contract No. N01-HV-02911-1, Annual Report, 1981; May.
28. Blubaugh A, et al. Development of an implantable electrohydraulic left heart assist system. NIH Report N01-HV-02911-2, 1981; May.
29. Blubaugh A, et al. Development and evaluation of a pneumatic left ventricle assist thermal energy system. NIH Report N01-HV-92909, 1982; August.
30. White M, et al. Implanted thermal engine system development. NIH Report N01-HV-92908, 1982, September.
31. Washizu T, Whalen R, Morinaga N, et al. Parathoracic left ventricular assist device (PVAD). *Trans Am Soc Artif Intern Organs* 1977; **23**:301-308.
32. Snow J, Ozawa K, Sukalac R, Kiraly R, Nosé Y. Initial results with three different electrically driven left ventricular assist systems (LVAS). *Trans Am Soc Artif Intern Organs* 1981; **27**:582-587.