

Experimental effect of negative pressure on ultrafiltration in hemodialysis

IN VITRO STUDY OF A SINGLE COIL OF THE KOLFF QUAD-COIL ARTIFICIAL KIDNEY

TADAMASA KON, M.D., PH.D.*
CLAUDIE WILLIAMS†
JOHN T. VENALECT, B.S.E.S.‡
SATORU NAKAMOTO, M.D.
DAVID C. WEBER, B.S.CH.E.§
CHARLES R. H. WILDEVUUR, M.D., PH.D.*
YUKIHIKO NOSÉ, M.D., PH.D.

Division of Research

Recently a quad-coil 'washing-machine artificial kidney' for home dialysis was developed by Kolff and his associates.^{1,2} One of the main advantages of this artificial kidney is that it makes possible a modest maintenance cost of home dialysis. Moreover, the cost of the unit itself is only about \$350, an amount that is much less than other commercially available artificial kidneys. However, there have been several disadvantages to this artificial kidney.

This dialysis system was designed to be operated without a blood pump, to simplify the procedure of home dialysis. The coils were made to produce a flow rate of from 250 to 300 ml per minute; a low ultrafiltration pressure is produced by only arterial pressure. To increase ultrafiltration, a high concentration of dextrose was added to the rinsing fluid. Khastagir and associates² reported adverse effects of this method. For intermittent hemodialysis, at least three pounds of water should be removed during each period of dialysis. For those patients whose kidneys still can produce urine, a quad-coil artificial kidney is effective, since they do not need additional ultrafiltration, only removal of waste products such as urea and creatinine.

At this time the Kiil artificial kidney³ and the Kolff twin-coil artificial

This study was supported by a research fund from The Cleveland Clinic Foundation, and The John A. Hartford Foundation, Inc.

* *Research Fellow, Artificial Organs Research Laboratory.*

† *Technician, Artificial Organs Research Laboratory.*

‡ *Consultant, Artificial Organs Research Laboratory; Chief Engineer, Product Design and Manufacturing Corporation, Willoughby, Ohio.*

§ *Chemical Engineer, Artificial Organs Research Laboratory.*

kidney⁴ are the most popular artificial kidneys for home dialysis. Both types of artificial kidney have good ultrafiltration capabilities. The Kolff twin-coil artificial kidney has a high resistance: to obtain a flow of 150 ml per minute a pressure of more than 200 mm Hg is required. The high pressure differences inside and outside the membrane will give adequate ultrafiltration. However, the use of a blood pump, which is necessary to this specific apparatus, is not desirable for home dialysis.

A pressure difference between blood and dialysate can also be obtained by using a vacuum outside the membrane instead of raising the positive pressure inside the membrane. With a negative pressure of 200 mm Hg in the dialysate, the pressure gradient across the membrane will be 300 mm Hg, with the positive pressure of 100 mm Hg in the blood compartment.

The Kiil artificial kidney uses negative pressures. These negative pressures are produced by sucking the dialysate solution through the artificial kidney. Thus, inside the artificial kidney, the negative pressure results in a higher pressure gradient across the membrane. The Kiil artificial kidney can remove water sufficiently to avoid overhydration. In the study we report here, an attempt was made to give these same ultrafiltration capabilities to the Kolff quad-coil washing-machine artificial kidney by using a vacuum.

Preliminary trial

Strength of the washing machine. The washing machine currently used for hemodialysis was dismantled to test each part against a pressure of more than -200 mm Hg. The type of machine* used was able to tolerate -8 inches of mercury (-200 mm Hg) for four days, and also no oil leaked through the fixed agitator into the fluid inside.

A pressure of more than -12 inches of mercury (-300 mm Hg) was applied. At this pressure the walls of the washing machine showed some degree of cave-in. It was difficult to use pressures up to -20 inches of mercury.

The vacuum pump. Three types of vacuum pumps were tested: a strong, high-powered vacuum pump;† a small vacuum pump;‡ a laboratory aspirator.§ The small aspirator can give a sufficient pressure up to -30 inches of mercury.

Preliminary tests were made with these three types of vacuum pumps and all of them were found to be adequate. All experiments afterward were performed with a simple laboratory aspirator. The simple aspirator

* *Maytag Wringer type of washing machine, The Maytag Company, Newton, Iowa.*

† *Model #25.65-V-2, Gast Manufacturing Company, Benton Harbor, Michigan.*

‡ *Duo-Seal Vacuum Pump, W. M. Welch Manufacturing Company, Chicago, Illinois.*

§ *Suggested and supplied by F. Merlin Bumpus, Ph.D., Division of Research, Cleveland Clinic.*

is inexpensive (\$1.50), but in order to get sufficient negative pressure it is necessary to use 1 gal of water per minute. If one dialysis lasts 8 hours, and a total of 8 dialyses is required per month, it will be necessary to have 4,000 gal of water, which will cost about \$7.00. The cost per dialysis will then be between 80 and 90 cents. In contrast, if we use an ordinary small vacuum pump, the cost of the vacuum pump will be \$30, but the cost per dialysis will be negligible.

Experimental method

The special lid for the washing machine is shown in *Figure 1A*. A negative-pressure gauge that will register up to 30 inches of mercury, and a vacuum applicator and its attachment are mounted. In order to be able to attach and to detach an arteriovenous shunt, a 48-mm wide and 32-mm high area was prepared where a Silastic no. 502* (now RTV no. 382) arteriovenous line adapter is seated (*Fig. 1B*). A slit is at the top of this adapter. The polyvinyl tubing to connect to the dialyzer can be pushed inside this slit, which will fit the channels that are parallel to the Silastic mold. The bottom of this Silastic block has the same contour as the rim of the washing machine and fits it exactly. The rubber gasket secures the plexiglass plate and Silastic block for the arteriovenous tubes. *Figure 2* shows the entire apparatus. The vacuum applicator tube is connected to the aspirator. Through this tube the negative pressure is applied inside the washing machine. On the opposite side of the vacuum applicator there is a valve for the automatic vacuum regulator.† This can also be regulated manually by the negative-pressure gauge.

The experiments were performed with a single coil of the Kolff quad-coil artificial kidney. The surface area comprises 0.315 m² of 4.5-cm wide cellulose tubing that is 3.5 m long. The polypropylene screen‡ with openings of 4 mm was used. In order to simulate blood flow, Travenol's microrotary pump§ was used, and controlled the flow from 0 to 150 ml per minute. The pressure was measured at the inflow and outflow tubes of the artificial kidney. Simulated blood was collected in a separate container. Flow was measured by calibrating the revolutions per minute of the pump, and also by direct measurement each time. An experiment was performed to determine the following relationships: (1) pressure-flow relationship of a single coil of the Kolff quad-coil artificial kidney, with and without negative pressure; (2) priming volume of the coil with and without negative pressure; (3) ultrafiltration of the coil without dextrose and with negative pressure; (4) urea clearance of the coil with and

* Dow Corning Corporation, Midland, Michigan.

† Model #26210-10, Matheson Scientific Inc., Cleveland, Ohio.

‡ Norddeutsche Seekablewerke Aktiengesellschaft, Nordenham, West Germany.

§ Travenol Laboratories Inc., Morton Grove, Illinois.

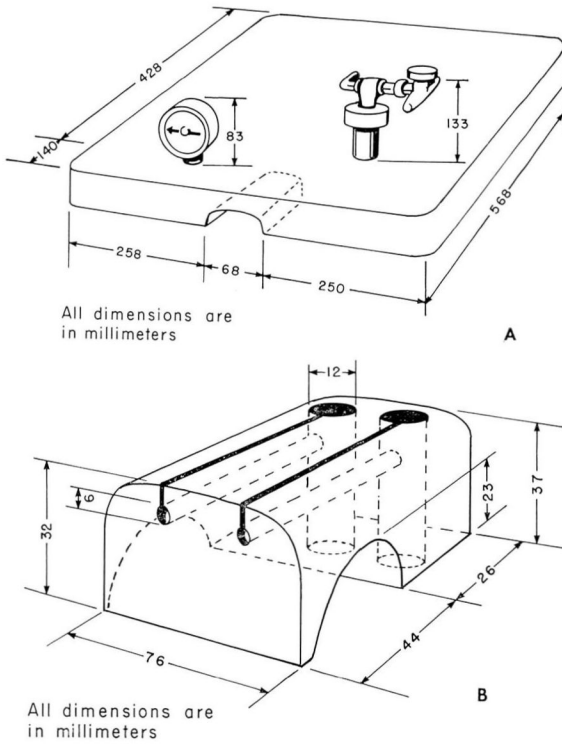

Fig. 1. A, Special vacuum lid for the washing machine. B, Arteriovenous tube inlet and outlet Silastic adapter.

without negative pressure; (5) effective dialysis surface area, determined by staining with Evans blue dye.⁵

(1) *Pressure-flow relationship* (Fig. 3). By increasing the negative pressure, the flow rate obtained by the same inlet pressure was increased extensively. A negative pressure of 100 mm Hg increased the flow rate almost 100 percent. A negative pressure of 200 mm Hg increased the flow rate 200 percent.

(2) *Priming volume* (Fig. 4). By applying negative pressure, the priming volume of the single coil of the artificial kidney increased.

(3) *Ultrafiltration performance* (Fig. 5). Water was removed at a rate of 85 ml per hour per coil by an inflow pressure of 100 mm Hg and an outside pressure of -200 mm Hg. By extrapolation, when four coils are used, an ultrafiltration rate of 340 ml per hour (85×4) can be achieved, on the basis of about 2,720 g (6 lb.) of water removed during an 8-hr period of hemodialysis.

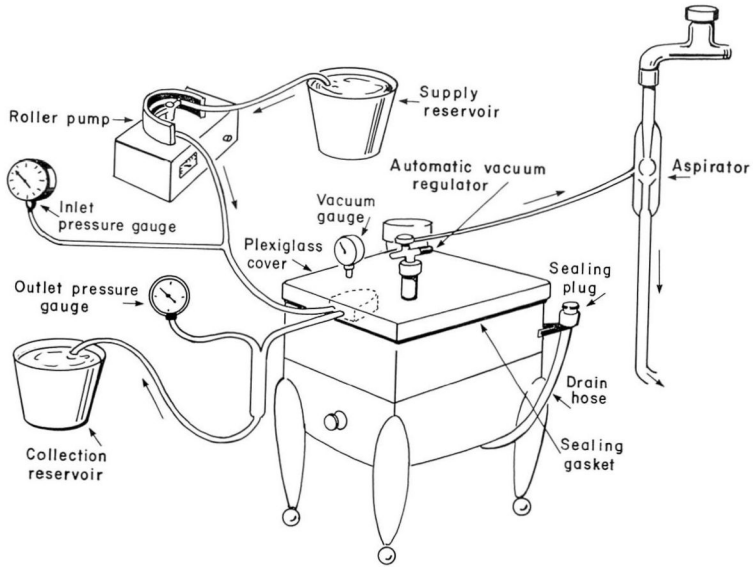

Fig. 2. Experimental setup for vacuum attachment to the washing-machine Kolff quad-coil artificial kidney.

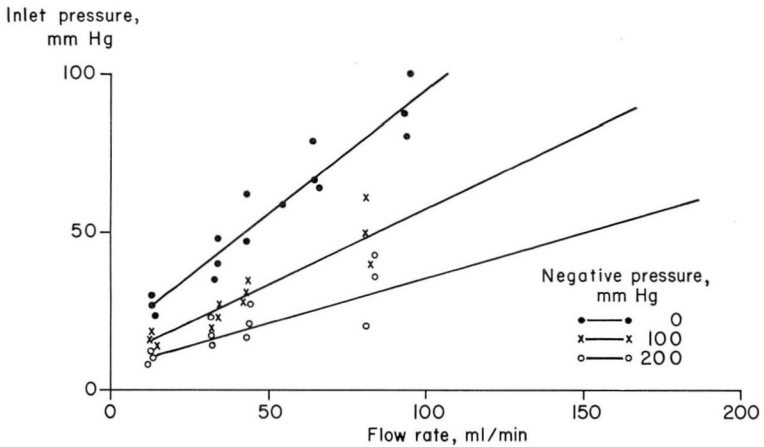

Fig. 3. Graph showing pressure-flow relationship of a single coil of the Kolff quad-coil artificial kidney.

(4) *Urea clearance* (Fig. 6). Urea clearance rate was reduced by increasing the negative pressure. With a pressure of -100 mm Hg, a 29 percent reduction in urea clearance occurred, and at a pressure of -200 mm Hg, a reduction of 64 percent occurred.

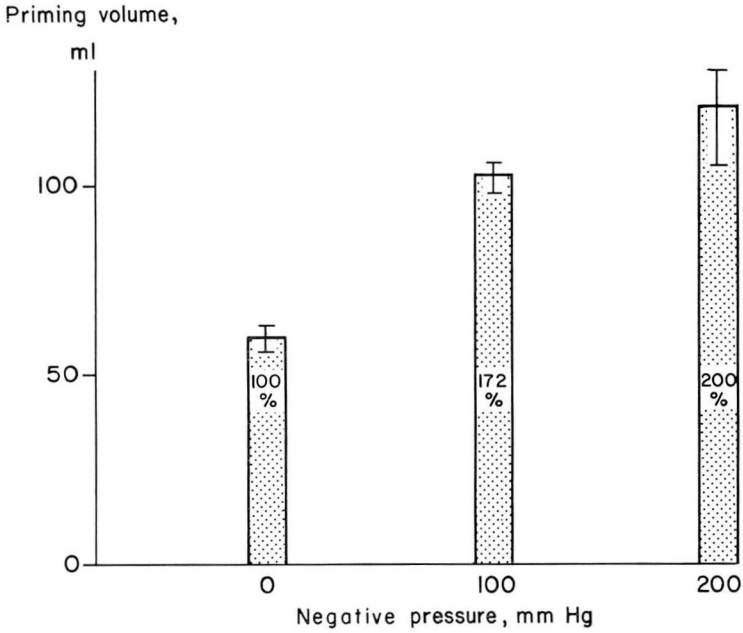

Fig. 4. Graph showing relationship of priming volume and negative pressure in a single coil of the Kolff quad-coil artificial kidney.

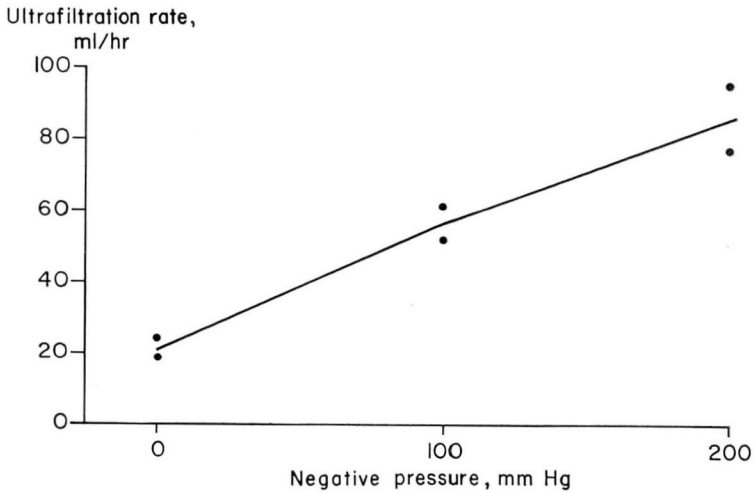

Fig. 5. Graph showing relationship of ultrafiltration rate and negative pressure in a single coil of the Kolff quad-coil artificial kidney.

EFFECT OF NEGATIVE PRESSURE ON ULTRAFILTRATION IN HEMODIALYSIS

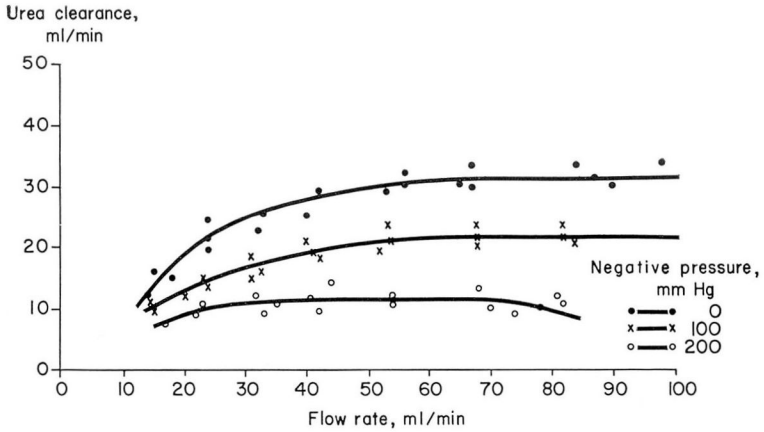

Fig. 6. Graph showing relationship of urea clearance rate and flow rate in a single coil of the Kolff quad-coil artificial kidney.

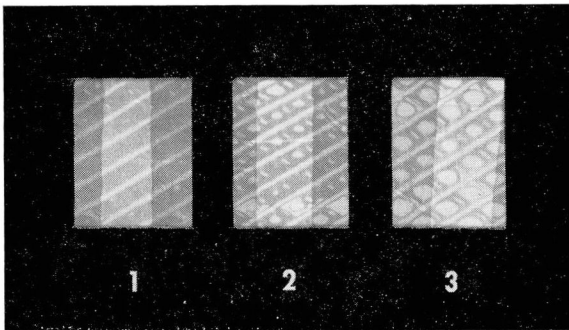

Fig. 7. Evans blue stained cellulose membrane (a single coil of the Kolff quad-coil artificial kidney was suspended in the dialysate, which contained 0.5 percent Evans blue dye per 72 liters for about one hour).

- 1 = no negative pressure applied.
- 2 = -100 mm Hg pressure applied.
- 3 = -200 mm Hg pressure applied.

The inside pressure was about 50 mm Hg; the ineffective area is not stained.

(5) *Effective dialysis surface* (Fig. 7). By increasing the negative pressure, the effective dialysis surface area was decreased. The ineffective surface for dialysis is indicated by the unstained area on the cellulose membrane.

COMMENT

To increase the efficiency of ultrafiltration in hemodialysis, it is necessary to increase the pressure gradient across the dialyzing membrane. If

it is necessary to remove 6 lb. of water from the patient during an 8-hr period of dialysis, a pressure of -200 mm Hg in the dialysate compartment must be applied. However, by applying such a negative pressure, there were two undesirable results. The first result was an increase in priming volume of about 200 percent. In the entire system a priming volume increase of 240 ml (60×4) is expected. The second result was a decrease in the urea clearance rate. The urea clearance efficiency of the coil was 14 ml per minute (about 50 ml per minute for four coils). This means that during the dialysis only water would be removed, and not an adequate amount of urea. The most desirable urea clearance rate is more than 60 ml per minute.

A negative pressure of 100 mm Hg in the dialysate compartment will permit 4 lb. of water to be removed in 8 hr. With a pressure of -100 mm Hg, the priming volume of four coils would increase about 175 ml, and the decrease in urea clearance would be about 30 percent. The calculated urea clearance for four coils was 80 ml per minute, which is quite satisfactory. Therefore, it seems that a negative pressure of -100 mm Hg is most desirable in this setup.

The results of staining the dialyzing membrane, with Evans blue dye, indicate that the decrease in urea clearance was due to the reduction of effective surface area, caused by the adjacent membranes being in direct contact with each other. The screen used to separate the membrane is not ideal.

Since the quad-coil artificial kidney was developed for a low-pressure system, the screen used in this artificial kidney is rather weak. A stronger screen is necessary. The selection of an appropriate screen will eliminate the undesirable performance of the coil. The indications for using the quad-coil artificial kidney for home dialysis will be broadened when these minor modifications have been made. By using a different screen and by controlling the priming volume, efficiency can be expected to improve.

CONCLUSION

A pressure of -100 mm Hg in the dialysate compartment is the most desirable pressure for the Kolff quad-coil artificial kidney to give ultrafiltration of more than 3 lb. per 8-hr dialysis. The negative pressure will cause a decrease in urea clearance rate and an increase in the priming volume. It seems appropriate to investigate the possibility of obtaining a better screen material than now in use, which will be more effective under high pressures and will better control the priming volume. The simple vacuum attachment described is recommended for the Kolff quad-coil artificial kidney for home dialysis, if the additional ultrafiltration is needed.

REFERENCES

1. Kolff, W. J.: Introduction of a simple artificial kidney in the United States; result of international cooperation. *Cleveland Clin. Quart.* **34**: 151-158, 1967.
2. Khastagir, B., and others: The four-coil artificial kidney for home dialysis. *Trans. Amer. Soc. Artif. Intern. Organs* **13**: 14-18, 1967.
3. Eschbach, J. W., Jr., and others: Unattended overnight home hemodialysis. *Trans. Amer. Soc. Artif. Intern. Organs* **12**: 346-356, 1966.
4. Hampers, C. L., and Merrill, J. P.: Hemodialysis in the home—13 months' experience. *Ann. Intern. Med.* **64**: 276-283, 1966.
5. Erben, J., and others: Letters. Colorimetric determination of effective dialysis area of artificial kidney. *J.A.M.A.* **202**: 72, 1967.